

DUO 6 - (DMXRS. DMXRD)



IMPORTANT SAFETY INFORMATION. READ AND FOLLOW ALL SAFETY INSTRUCTIONS

IMPORTANT SAFETY INFORMATION. READ AND FOLLOW ALL SAFETY INSTRUCTIONS. Before wiring to power supply and during servicing or relamping, turn off power at fuse or circuit breaker. All servicing or relamping must be performed by qualified service personnel. Product must be grounded to avoid potential electric shock or other potential hazard. Product must be at locations and at heights and in a manner consistent with its intended use, and in compliance with Electrical Code and local codes.

SAVE THESE INSTRUCTIONS FOR FUTURE REFERENCE.

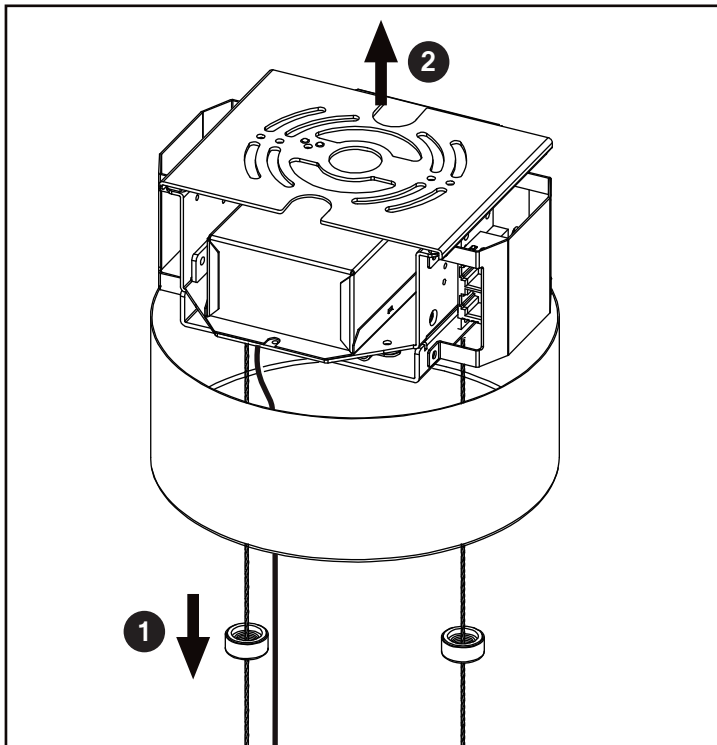

Step 1

Loosen the bolt on the canopy.

Step 2

Remove the power module from the canopy.

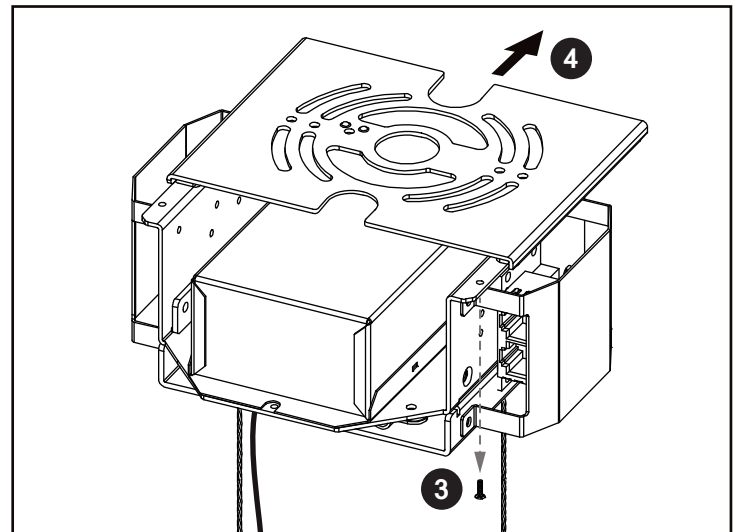

Step 3

Remove the screw on the bracket in order to be able to loosen the mounting plate.

Step 4

Slide out the mounting plate.

DUO 6 - (DMXRS. DMXRD)

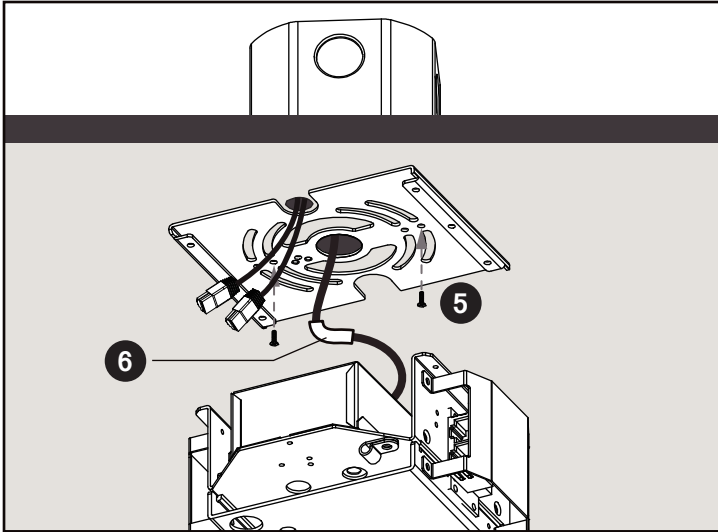

Step 5
Place the mounting plate onto the ceiling and screw it in place.

Step 6
Connect wires (please refer to wire diagram).

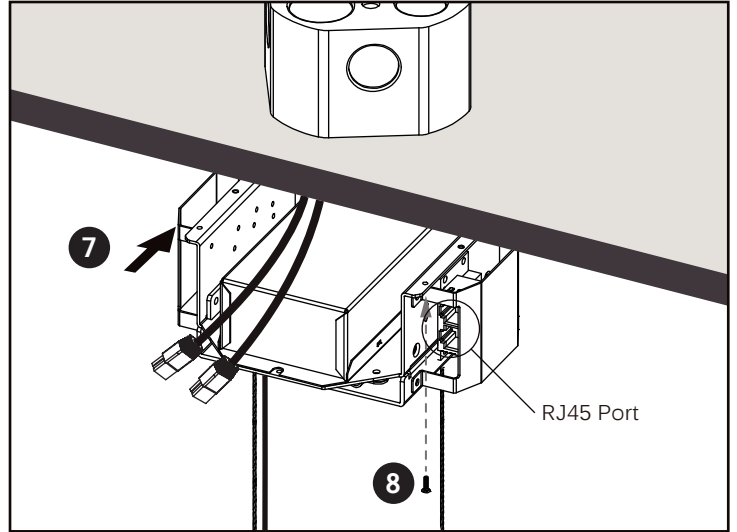

Step 7
Slide the power module onto the mounting plate and connect the RJ45 Cables to the available ports.

Step 8
Screw the bolt to the mounting plate.

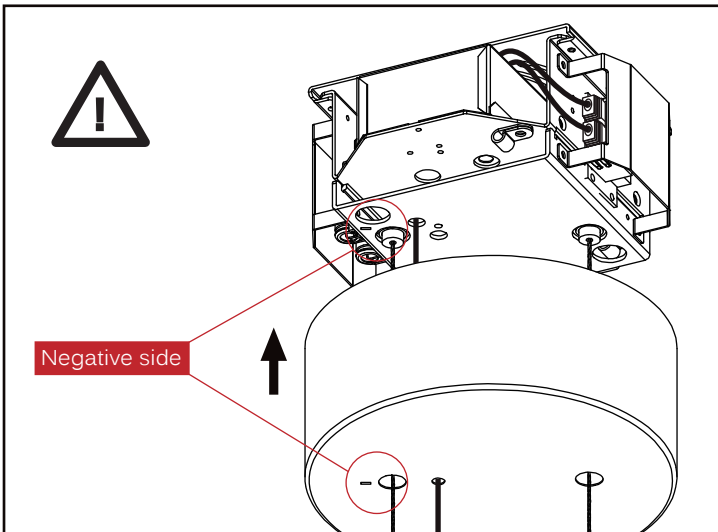

Step 9
Place the canopy around the power module. Ensuring that the negative side is aligned (clearly marked).

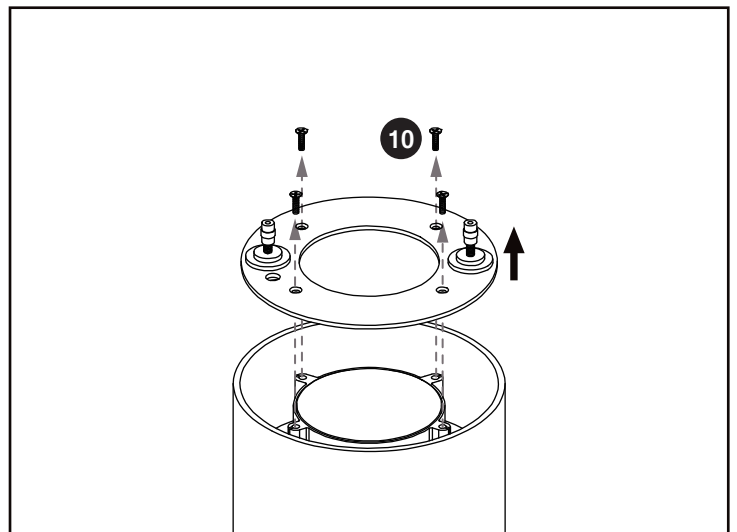

Step 10
Unscrew the ring plate and loosen the cable gripper, Removing the plate from the fixture.

DUO 6 - (DMXRS. DMXRD)

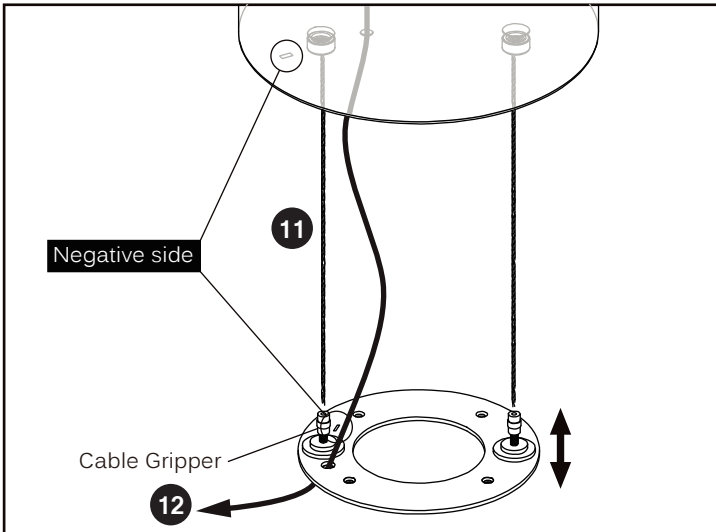

Step 11
Slip the wire through the cable gripper and adjust to desired height, tightening the gripper to lock in place. (Aligning the negative side)

Step 12
Slip the dimming cable through the dimming port.

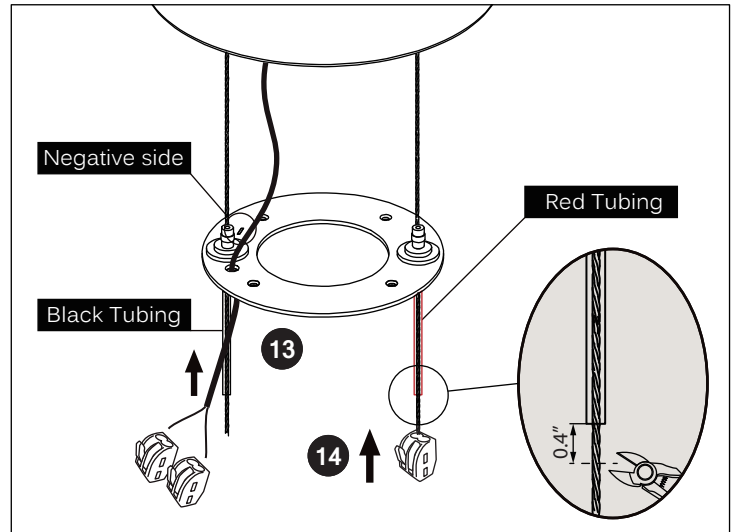

Step 13
Slip the black protective tubing over the negative side wire and the red tubing over the other wire. Ensuring end to end tubing coverage.

Step 14
Leave a 0.4" gap before cutting both wires and connect both wires and dimming cable to a WAGO connector.

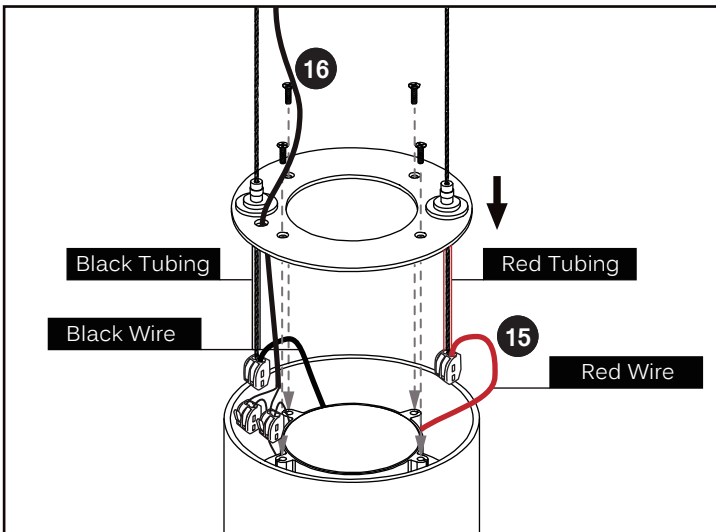

Step 15
Connect the black tubing to the black wire and red tubing to the red wire as well as the dimming WAGO connectors to the dimming wires available.

Step 16
Screw the ring plate to the fixture.

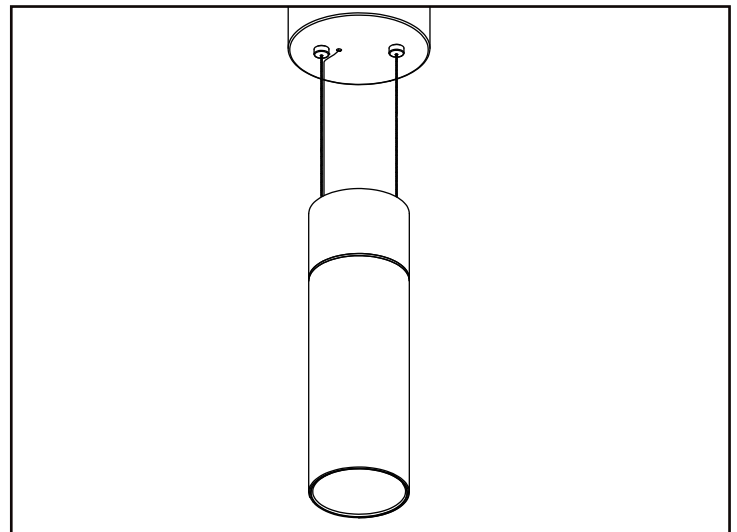

Step 17
Installation Complete.

DUO 6 - (DMXRS. DMXRD)



Wiring Diagram

DMXRS · DMXRD

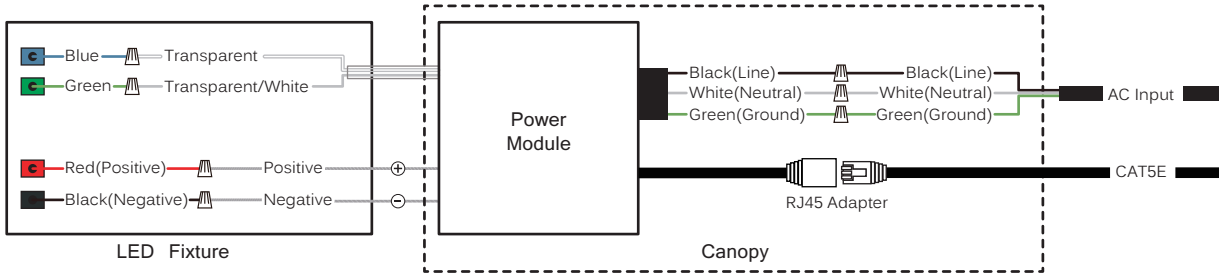

DMXRS · DMXRD / Remote Power

