

# ADVANCED HIGH CEILING 4" Rev Series - Emergency Pack

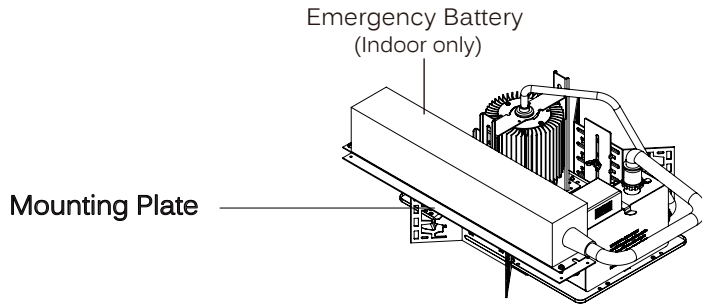

## Emergency Pack



## Wiring Diagram

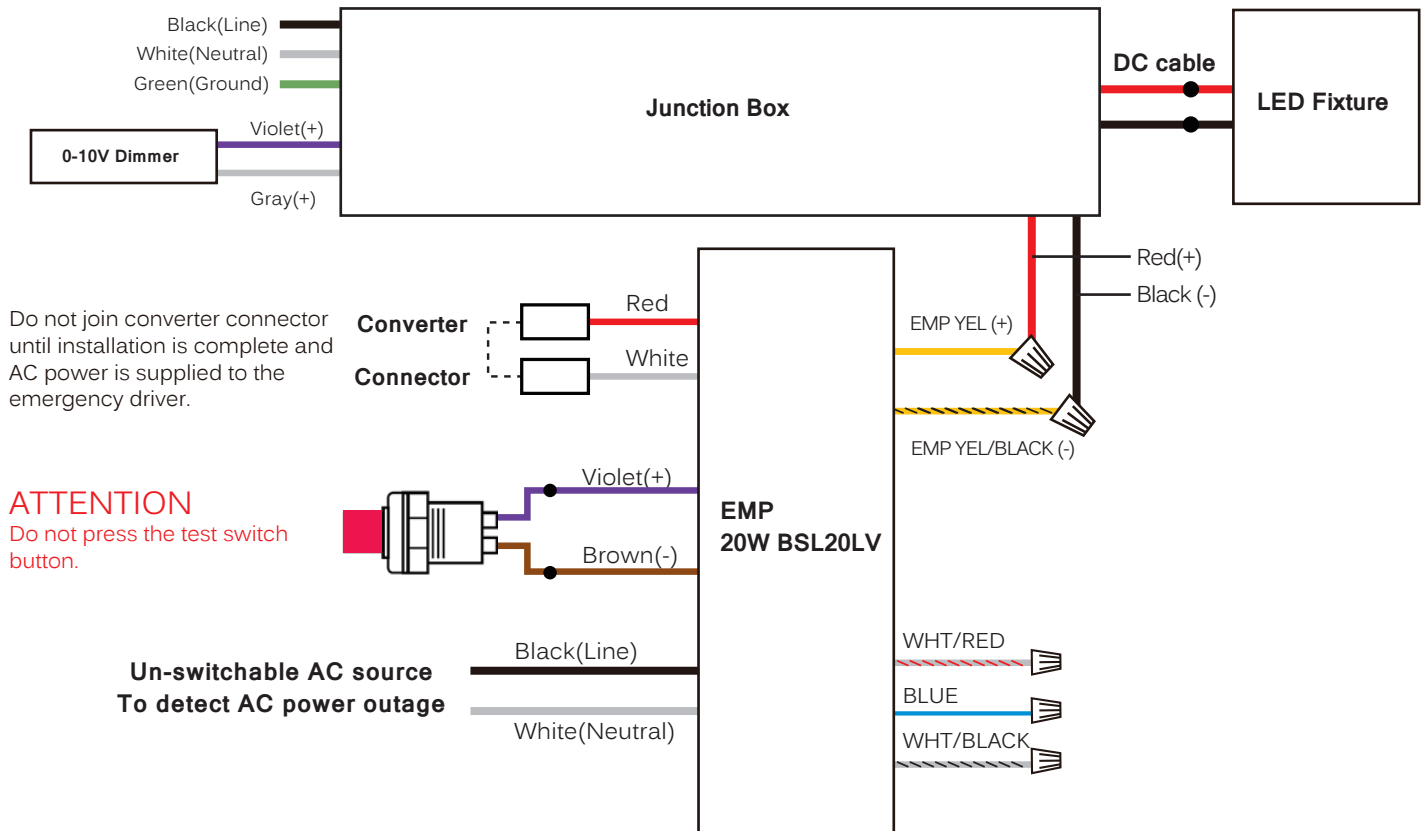

## Test method

Disconnect the AC power of the LED fixture and EMP. The LED Fixture should be lit by EMP.

# BSL20LV-DF

PHILIPS  
bodine

## Installation Instructions

EMERGENCY LED DRIVER  
UNIVERSAL INPUT

CLASS 2 OUTPUT



CONFORMS TO  
UL STD 924  
CERTIFIED  
TO CSA STD  
C22.2 NO.141



### **! IMPORTANT SAFEGUARDS !**

**WHEN USING ELECTRICAL EQUIPMENT, BASIC SAFETY PRECAUTIONS SHOULD ALWAYS BE FOLLOWED, INCLUDING THE FOLLOWING:**

## READ AND FOLLOW ALL SAFETY INSTRUCTIONS

1. To prevent high voltage from being present on yellow & yellow/black output leads prior to installation, converter connector must be open. Do not join converter connector until installation is complete and AC power is supplied to the emergency driver. Do not join converter connector until installation is complete and AC power is supplied to the emergency driver.
2. This product is for use with an emergency LED lighting load and supplies 20.0 W of power with a maximum rated current of 1.1 A with a maximum voltage of 50 VDC in emergency mode for a minimum of 90 minutes.
3. Make sure all connections are in accordance with the National Electrical Code or Canadian Electrical Code and any local regulations.
4. To reduce the risk of electric shock, disconnect both normal and emergency power supplies and converter connector of the emergency driver before servicing.
5. This emergency driver is suitable for both factory or field installation. For field installation, please see the instructions on page 2.
6. This product is suitable for use in damp locations where the ambient temperature is 0°C minimum, +50°C maximum. Product is not suitable for heated air outlets and wet or hazardous locations.
7. An unswitched AC power source is required (120-277 VAC, 50/60 Hz).
8. Do not install near gas or electric heaters.
9. Do not attempt to service the battery. A sealed, no-maintenance battery is used that is not field replaceable. Contact the manufacturer for information on service.
10. The use of accessory equipment not recommended by the manufacturer may cause an unsafe condition.
11. Do not use this product for other than intended use.
12. Servicing should be performed by qualified service personnel.
13. Equipment should be mounted in locations and at heights where it will not be subjected to tampering by unauthorized personnel.
14. For Canadian application the output terminals should be in compliance with the accessibility requirement of the Canadian Electric Code.

### SAVE THESE INSTRUCTIONS



Ni - Cd

**THIS PRODUCT CONTAINS A RECHARGEABLE NICKEL-CADMIUM BATTERY.  
THE BATTERY MUST BE RECYCLED OR DISPOSED OF PROPERLY.**

ADVANCED HIGH CEILING

# Emergency Battery

## Specifications

### ETL Listed

For Field or Factory Installation  
(Indoor and Damp)

### UL Component Recognized

For Factory Installation  
(Indoor and Damp)

### Illumination Time

90 Minutes

### Full Warranty

5 Years (NOT pro-rata)

### Universal Input Voltage

120-277 VAC, 50/60 Hz

### AC Input Current

95 mA Maximum

### AC Input Power Rating

8.5 W Maximum

### Output Current and Voltage

BSL20LV 1A-0.40A 20V-50V (Class 2)

BSL20MV 0.40A-0.15A 50V-130V

BSL20HV 0.16A-0.10A 125V-200V

### Output Power

20.0 W

### Test Switch/Charging Indicator Light

Illuminated Test Switch 2W-ITS  
(2W-ITS can be mounted up to 50 feet from fixture)

### Battery

High-Temperature, Maintenance-Free  
Nickel-Cadmium Battery  
7- to 10-Year Life Expectancy

### Battery Charging Current

275 mA

### Recharge Time

24 Hours

### Temperature Rating (Ambient)

0°C to +50°C (32°F to 122°F)

### Dimensions

16.6" x 2.8" x 2.85" (422 mm x 71 mm x 73 mm)

2' (610 mm) Flexible Conduit

Mounting Center 16.05" (408mm)

### Weight

7.1 lbs. (3.22 kg)

## Benefits:

- Listed for field installation - UL 924 and CSA C22.2 No. 141 Emergency Lighting Compliant
- Output Class 2 Compliant (BSL20LV only)
- Enables LED Linear strip fixtures to meet Emergency Code requirements
- Emergency mode nominal lumen output of 2,000 lumens
- Universal input (120-277 VAC)
- 2 wire input reduces wiring errors
- Auto-sensing output within each range
- RoHS Compliant

## Dimensions:

16.6" x 2.8" x 2.85" (mounting center - 16.05")

